

KD **one**

DIGITAL COLOR LCD HANDS FREE VIDEO PHONE

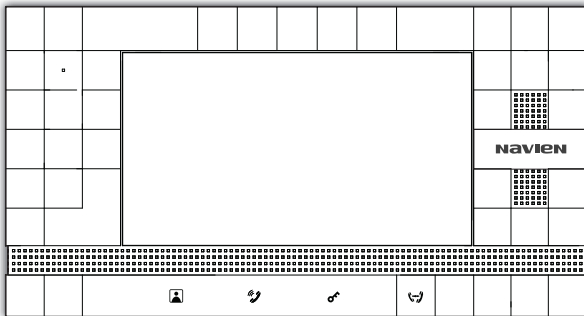

Model **UHA-742SG/M**

- Please carefully read this User's Guide (in particular, precautions for safety) before using a product and follow instructions to use a product exactly.
- The company is not responsible for any safety accidents caused by abnormal operation of the product.

Navien User Manual

Contents

Warning and important safeguards	4
Components	8
Installation	9
Product specifications	10
Operation	11
Manager mode	13
Manager mode(Video memory equipped model)	17
Wiring diagram	20
Warranty	21

WARNING

- To prevent injury, the following safety precaution should be observed during installation, use and servicing of the unit.

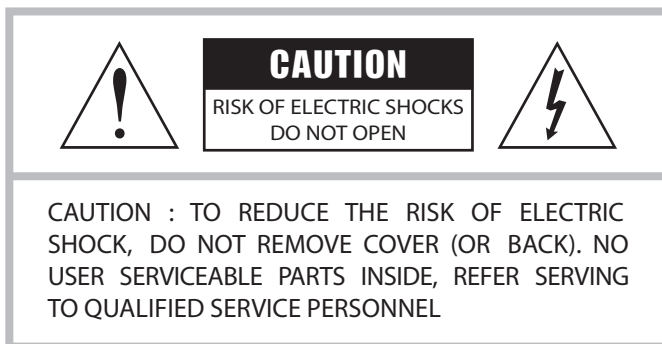

This symbol is intended to alert the user to the presence of uninsulated “dangerous voltage” within the product’s enclosure that may be of sufficient magnitude to constitute a risk of electric shock to persons.



This symbol is intended to alert the user to the presence of important operating and maintenance (servicing) instructions in the literature accompanying the appliance.

Apparatus shall not be exposed to dripping or splashing and that no objects filled with liquids, such as vases, shall be placed on the apparatus.

Note : Change or modification not expressly approved by the party responsible for compliance could void the user’s authority to operate the equipment.
This manual is based on the date as shown in the right and specification are subject to change without notice for quality improvement

For the customers

This equipment has been tested and found to comply with the limits for a Class B digital device, pursuant to Part 15 of the FCC Rules.

These limits are designed to provide reasonable protection against harmful interference in a residential installation. This equipment generates, uses, and can radiate radio frequency energy and, if not installed and used in accordance with the instructions, may cause harmful interference to radio communication.

However, there is no guarantee that interference will not occur in a particular installation. If this equipment does cause harmful interference to radio or television reception, which can be determined by turning equipment on and off, the user is encouraged to try to correct the interference by one or more of the following measures:

- Reorient or relocate the receiving antenna.
- Increase the separation between the equipment and receiver
- Connect the equipment into an outlet on a circuit different from that to which the receiver is connected
- Consult the dealer or an experienced radio/TV technician for help

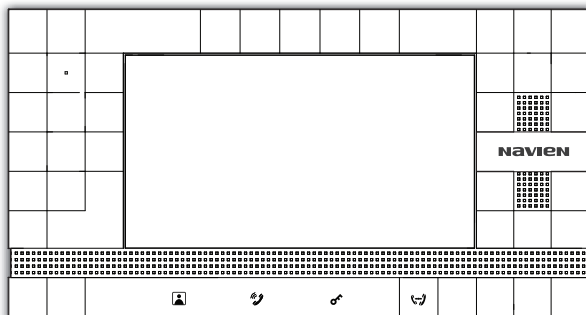

Important Safeguards

1. Read Instructions

All the safety and operating instructions should be read before the unit is operated.

2. Retain Instructions

The safety and operating instructions should be retained for future reference.

3. Follow Instructions

All operating instructions, maintenance and all warnings should be followed.

4. Cleaning

Turn off the power of unit before cleaning. Do not use liquid or aerosol cleaners. Use a dry cloth for the body of unit.

5. Attachments

Do not use attachments not recommended by the unit product manufacturer, as they may be hazardous or cause damage.

6. Heat and Moisture

Do not expose this unit direct sunlight and rain for reliable operation.

7. Installation

Do not install this unit on an unstable place (hot, cold, humid or excessive dust). Use only with a mounting accessory recommended by the manufacturer or sold with the unit.

Installing this unit should follow instructions of manufacturer and qualified service personnel.

8. Ventilation

Slot and opening in the cabinet are provided for ventilation to ensure reliable operation of the unit and to protect it from overheating.

These openings must not be blocked or covered. Never place your unit on a bed, sofa, rug, or similar surface ;or on near a radiator or heat register.

This unit should not be placed in a built-in installation such as a bookcase or rack unless proper ventilation is provided.

9. Power Sources

This unit should be operated only from the type of power source indicated on the label. If you are not sure of the type of power supply to your home, consult your appliance dealer or local power company.

To operate the unit by battery or other power source, consult the operating instructions.

10. Grounding and Polarization

This unit may be equipped with either a polarized 2-wire AC line plug (a plug having one blade wider than the other) or a 3-wire grounding type plug, a plug having a third (grounding) pin. The 2-wire polarized plug will fit into the power outlet only one way. This is a safety feature. If you are unable to insert the plug fully into the outlet, try reversing the plug. If the plug still fails to fit, contact your electrician to replace your outlet.

Do not defeat the safety purpose of the polarized plug.

11. Overloading

When using this product, do not overload the power outlets or extension cords as this could cause fire or electric shock.

12. Accessories

Do not place this unit on an unstable cart, stand, tripod, bracket, or table. If the unit falls, it could cause injury or damage to the system.

13. Object and Liquids

Never push objects of any kind into this unit through the openings.

Never spill liquid of any kind on the unit.

14. Servicing

Do not attempt to service this unit yourself as opening or removing covers may expose you to dangerous voltage or other hazards. Refer all servicing to qualified service personnel.

15. Power Line

The system should not be located near power lines or electric light or power circuits.

16. Damage Requiring Service

Unplug this unit from the wall outlet and refer to servicing to a qualified service technician if any of the following occur.

- a. If the power supply cord or plug is damaged
- b. If any liquid has been spilled into objects have fallen in the unit
- c. If the unit has been exposed to rain or water
- d. If the unit has been dropped or otherwise damaged
- e. If the equipment exhibits a distinct change in performance

17. Replacement Part

When replacement parts are required, use replacement parts specified by the manufacturer.

COMPONENTS

■ Main body

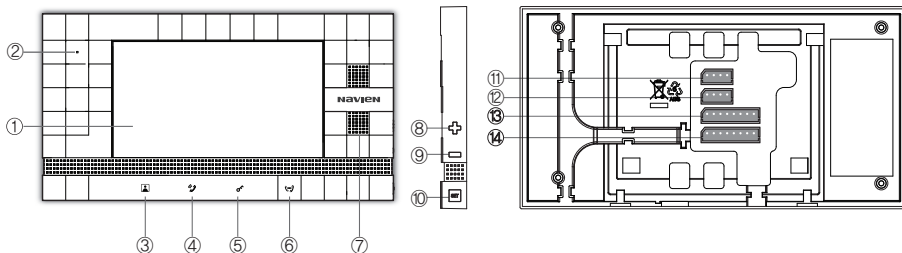

① LCD Screen	⑥ Intercom Button	⑪ Connection terminal for door camera #1
② Mic	⑦ Speaker	⑫ Connection terminal for door camera #2
③ Monitoring Button	⑧ +(Up) Button	⑬ Connection terminal for Intercom input
④ Talk Button	⑨ -(Down) Button	⑭ Connection terminal for Intercom output
⑤ Door Open Button	⑩ Set Button	

■ Fixing Bracket

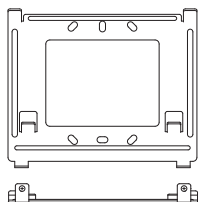

■ Mounting Hardware & Cable

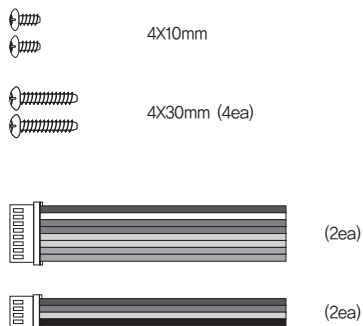

INSTALLATION

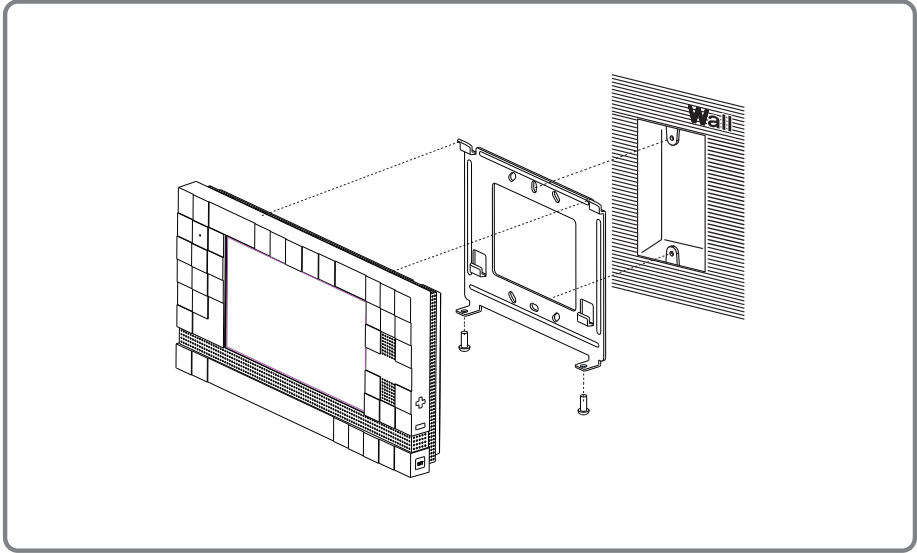

■ Standard height of video phone

1. After determining the mounting locations for both the outside camera and inside monitor
2. At the selected monitor mounting location, 1,450mm is suggested from the bottom.

<Caution>

Install the monitor away from the heat, moisture and direct sun rays.

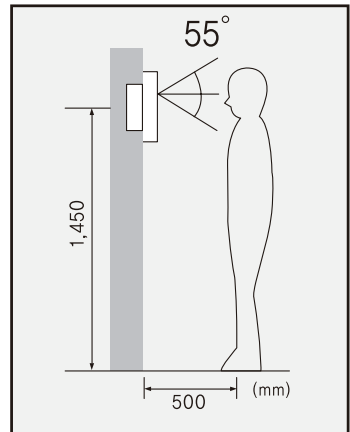

PRODUCT SPECIFICATIONS

■ Specifications

DIV.		Specification
Power Source		AC 100~240(50/60Hz)
Wiring		Doorphone : 4 wires in polarity Intercom : 8 wires in polarity
System Composition		- 2 Doorphones + Additional 3 intercoms
Distance		- DOOR : TIV 0.5(28M), TIV 0.65(50M), TIV 0.8(70M) (Up to the last Intercom)
Video Memory (Option)	Still Cut	256 Cuts
	Movie	5f/s, 5sec, 32clips
LCD Screen	LCD	7" Color TFT LCD
	Video input	1Vp-p/75Ω, Composite NTSC/PAL(Color)
Environmental Circumstance	Temp.	0°C ~ 40°C
	Humidity	Less than 90% (Relative humidity)
Dimensions	Size	254.5(W) x 135.5(H) x 32.0(D)mm
	Weight	UHA-742SG : 792g UHA-742SGM : 815g
Mounting		Wall surface mounted

OPERATION

■ When a visitor pushes a Call Button

When a visitor pushes the Call Button on the door-phone at the front door, the call is transferred to the Videophone

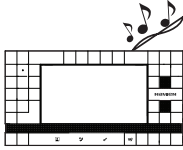

Call signal is ringing on the videophone, while "Talk" button is flickering, and the image of the visit appears on the screen.

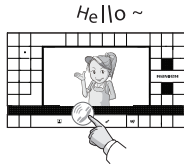

When Talk button is pressed, the conversation with the visitors starts, and "Talk" button LED illuminates.

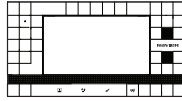

If you press the "Talk" button while talking with the visitor or the time limit of 1 minute is reached, the screen goes blank and the conversation ends.

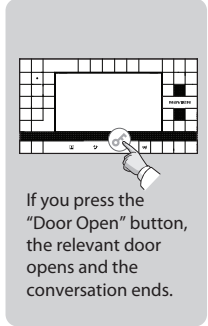

If you press the "Door Open" button, the relevant door opens and the conversation ends.

'DOOR#1' or 'DOOR#2' appears at the top of the screen

■ When using the Monitoring function

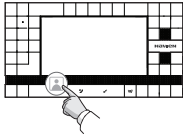

If you press the "Monitoring" button, pictures captured by the door-phone at the front door will appear on the screen.



If two door-phones are installed, door-phone #2 can also be monitored by pressing the "Monitoring" button once more.

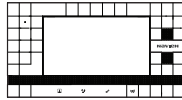

If you press the "Talk" button while using the monitoring function, talking activated through the door-phone that is currently installed.

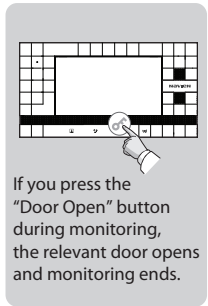

If you press the "Door Open" button during monitoring, the relevant door opens and monitoring ends.

'DOOR#1' or 'DOOR#2' appears at the top of the screen

If there's no input from the door phone camera, the "No Signal" message appears, which means there is no video signal.

■ Intercommunication between videophones (when they are connected)

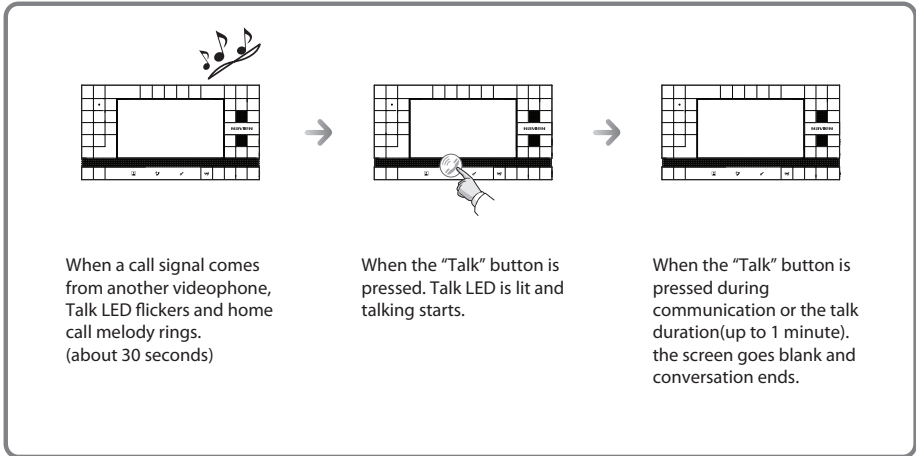

■ Call signaling to another videophone

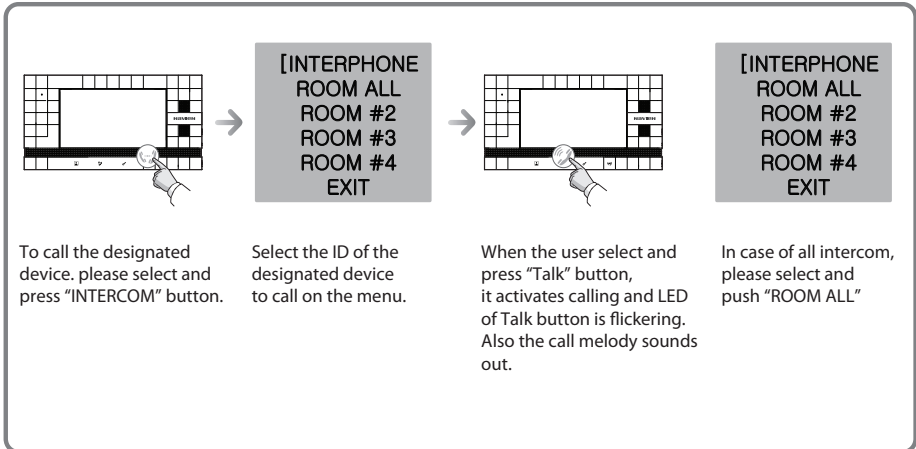

MANAGER MODE

How to control the volume for bell, talk and display

The user can adjust and set the volume of bell during call from door or additional intercom

The user can adjust and set the volume during talk between monitor and door.

The user can adjust and set the display status on LCD screen

1. Adjust the volume of the bell

- When the user pushes the button of "UP" or "DOWN" during the call from door or intercom, the status of the volume of bell on the down sided of screen.
- Using "UP" and "DOWN" button, the user can adjust the level of the volume by 1~8 steps. After adjustment of the volume, push "SET" button to complete the adjustment.

2. Adjust the volume of the talk

- When the user pushes the button of "UP" or "DOWN" during the talk with door or Intercom, the status of the volume of bell on the down sided of screen.
- Using "UP" and "DOWN" button, the user can adjust the level of the volume by 1~3 steps. After adjustment of the volume, push "SET" button to complete the adjustment.

3. Adjust the display status

- When the user pushes the button of "SET" button while the picture on, the adjustment status of the picture by [Bri] on the down sided of screen.
- Using "UP" and "DOWN" button, the user can adjust the level of the brightness by 0~8 steps. After adjustment of the brightness, the user push "SET" button to complete the adjustment of the brightness and goes to the next procedure of the adjustment of contrast by [Con].
- Using "UP" and "DOWN" button, the user can adjust the level of the contrast by 0~8 steps. After adjustment of the brightness, the user push "SET" button to complete the adjustment of the contrast and goes to the next procedure of the adjustment of color by [Col].
- Using "UP" and "DOWN" button, the user can adjust the level of the color by 0~8 steps. After adjustment of the color, the user push "SET" button to complete the adjustment of the Color.

※ [Bri] : Brightness, [Con] : Contrast, [Col] : Color

Manager mode is the product setting mode that allows an installer to configure the device environment (setting door-phone number and the type of door-phone camera) needed for operation.

- *Manager mode ends automatically and standby mode is on when about 1 minute passes without button input.
- When you are in Manager mode, you will not receive any door-phone, extension or interphone call.
- ※ The product must be turned off and on again to save and apply the configuration changed in Manager mode.
- ※ When power is OFF → ON in the middle of changing the configuration on Manager mode, the modification may fail to be applied.

To select MANAGER MENU

- Enter "MANAGER" mode by pressing and holding the Door Open button for more than 3 seconds in a standby state after power is on.



[Initial screen after it is switched on]



[MANAGER MODE SCREEN]

Set the type of device

- * Setting mode for MAIN Videophone and SUB Videophone.
- * Enter "MANAGER" mode by pressing and holding the Door Open button for more than 3 seconds in a standby state after power is on.
- In the menu of [MANAGER], when the user selects [DEVICE TYPE] by "Up" or "DOWN" and push "SET" button, the menu of [DEVICE TYPE] popped up on the screen.
- To use "Up" or "DOWN" button, the user can select MAIN PHONE.
- After selection, to finish the setting, push "SET". And menu of [MANAGER] popped up again.

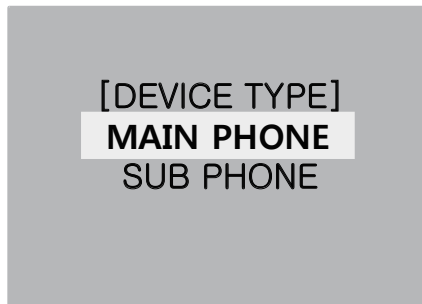

Set the PHONE ID

- If [DEVICE TYPE] is set as MAIN PHONE, the setting of PHONE ID is not possible. (ID of MAIN PHONE is 0)
- * If [DEVICE TYPE] is set as SUB PHONE, the user can set ID of SUB PHONE. (In case of SUB PHONE, default is 1)
- In the menu of [MANAGER], when the user selects [PHONE ID] by "Up" or "DOWN" and push "SET" button, the menu of [PHONE ID] popped up on the screen.
- To use "Up" or "DOWN" button, the user can select the designated ID by the changing of digit. After selection of ID, the user may push "SET" button to finish. (IDs of SUB Videophone are 3 from 01 to 03)
- After selection of ID of sub videophone, to finish the setting, push "SET". And menu of [MANAGER] popped up again.

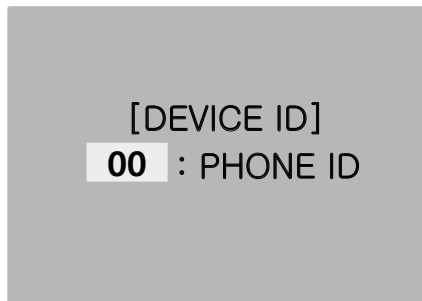

After setting of ID of videophone, please turn on the power definitely to keep the previous setting and changing.

Setting CAMERA NUM (setting the number of door-phones in line with the videophone)

*This is the mode that allows you to set the number of door-phones in line with the videophone.

*Set up as Door-phone 1 by default.

- Select [CAMERA NUM] from the [MANAGER] MENU using the "UP" and "DOWN" buttons .
If you push the "SET" button, [CAMERA NUM] appears, which indicates the current setup.
- Select the number of door-phones to be connected with videophone using the "UP" and "DOWN" buttons at the bottom, and then push the "SET" button.
- If you push the "SET" button, after completing the settings, the [MANAGER] MENU screen will appear again.



Setting CAMERA TYPE (setting the type of the door-phone camera)

*This is a mode that allows you to set the type of the door-phone camera to be connected with the videophone.

*Set up as PAL by default.

- Select [CAMERA TYPE] from [MANAGER] MENU using the "UP" and "DOWN" buttons, and then
If you push the "SET" button, [CAMERA TYPE] menu appears, which indicates current set up.
- Select the type of the door-phone camera to be connected with the videophone using the "UP" and "DOWN" buttons at the bottom and then push the "SET" button.
If you push the "SET" button, after the completion of settings, the [MANAGER] MENU screen appears again.



The changed configuration will be applied only after power is OFF/ ON one again.

※ Caution: The camera must be connected that matches the configuration setup.

If you fail to do this, (e.g., connecting PAL camera while set up as NTSC) the screen image may not appear correctly. Then, the screen is returned to the normal state when the power is OFF → ON

MANAGER MODE (Video memory equipped model)

Storing images of a visitor

* Storing, identifying and deleting images of visitors.

Storing images

- Storing of images is done automatically during call signaling to the door-phone, depending on how the user has set up STILL/VIDEO storing in the user menu.
- If there's no storage space, it overwrites to make the new capacity of recording.
(VIDEO : 5sec 32cut (5frames/1sec), STILL:256cut)

Playing images

- If VMM module is installed and there are stored images, push the 'UP' key on the right and enter 'PLAY' mode. By pushing the 'UP' and 'DOWN' keys, the stored images can be played in order.
- If VMM module is not installed, an Error sound may occur when you push the 'UP' and 'DOWN' keys on the right.
- If VMM module is installed and there's no stored image, "NO Image" appears.
- If image storage type is set up as STILL, only STILL images are stored and played; if set up as VIDEO, only video images are stored and played.
- If you push "SET" button on an image playing screen about 10 seconds passes, playing ends automatically.

User menu (VMM setting menu)

- You can enter the User menu, by pushing the "SET" button while in standby.
- User menu is set up in association with VMM, so if VMM is not installed an ERROR sound may occur when you pushing the "SET" button while in standby.
- User menu ends automatically if about 30 seconds passes without pushing a button.
- While you are in User menu, call signaling to door-phone or extensions.

EXIT : menu closing

TIME : VMM time setting (for indication of storage time during playing of images)

SAVE : STILL/VIDEO

DELETE : deleting all the images and videos

- ※ While you are in User menu, call signaling from other videophones or door-phone so only when the connected videophones are all in standby, it is possible.
- ※ When power is OFF → ON during setting data at User menu, the set data value may fail to be applied.

※ VMM : Video Memory Module

■ Additional functions (Video memory equipped model)

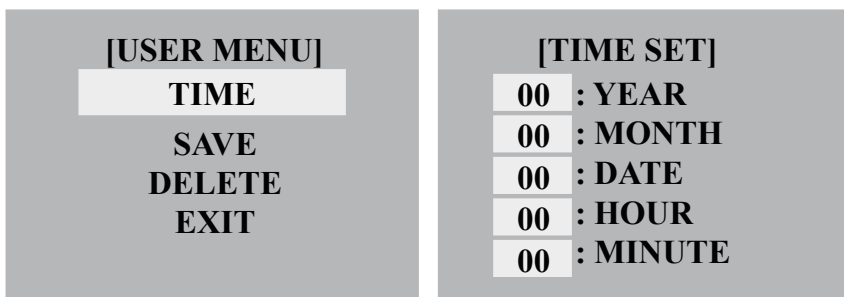

Setting the year

- When the "SET" button (one the right) is pushed from the standby screen, the User menu screen appears.
- If you select "SET" using the "UP" and "DOWN" buttons (on the right) on the Menu screen and push the "SET" button, YEAR, MONTH, DATE, HOUR and MINUTE appears.
- You can set the year using the "UP" and "DOWN" buttons, and if you push the "SET" button, you will move to Setting the month.

Setting the month

- Year setting is followed by Month setting.
- You can set the month using the "UP" and "DOWN" buttons, and if you push the "SET" button, you move to Setting the date.

Setting the date

- Month setting is followed by date setting.
- You can set the date using the "UP" and "DOWN" buttons, and if you push the "SET" button, you move to Setting the time.

Setting the hour

- Date setting is followed by time setting.
- You can set the hour using the "UP" and "DOWN" buttons, and if you push the "SET" button, you move to Setting the minute.

Setting the minute

- Hour setting is followed by minute setting.
- You can set the minute using the "UP" and "DOWN" buttons, and if you push the "SET" button, setup is complete and the data are stored.

Ending setup

- When minute setting is complete, the User menu screen appears again.

※ If time set mode ends without completion of minute setting, the data being set up may not be stored.

■ User menu (Video memory equipped model)



* Video storage type setup mode

- If you push the "SET" (on the right) button from the standby screen, the User menu screen appears.
- Select "SAVE" on the menu screen pushing the "UP" and "DOWN" buttons on the right, and push the "SET" button.
- The present storage type appears under selection.
- Select either VIDEO or STILL as storage type using "UP" or "DOWN".
(VIDEO : video(5 seconds) storage / STILL : still image storage)
- If you push the "SET" button, the User menu appears again.



- If you push the "SET" button on the standby screen, the User menu screen appears.
- Select "DELETE" on the menu screen using the "UP" and "DOWN" buttons, and push the "SET" button.
- Select either YES or NO using the "UP" and "DOWN" buttons and push the "SET" button.
(YES : delete all images / NO : Do not delete images)
- User menu screen appears again after the operation is completed.

WIRING DIAGRAM

■ System Wiring

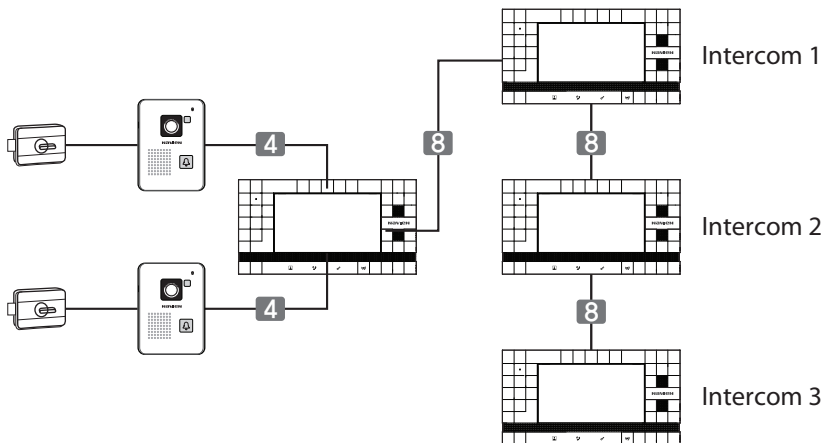

4 4wires. **8** 8wires.

■ Doorphone Wiring

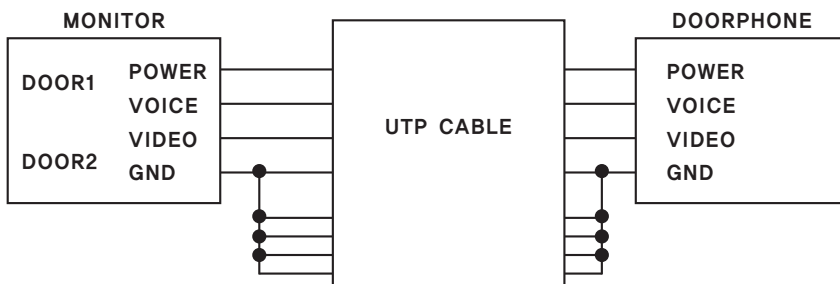

If UTP CABLE[CAT.5] is used, use 5th lines for GND line



Note :

Arbitrarily installed additional monitors occur the lower quality of video and voice transmission.

WARRANTY

Products are supplied with two(2) years return to base warranty.

From the date of purchase. We will repair or replace the defective item with a new or factory rebuilt replacement.

Condition

- 1.This warranty applies to the original purchaser only.
2. All warranty will be invalid if unauthorized repair or modification are made to the unit or in any case of accident, misuse, damage cause by improper installation and altered serial numbers.
3. The liability of is limited to the cost of repair/replacement of the unit under warranty.
4. If you need a warranty service, you should send the product to our customer service Dep't or dealer office. The product in all cases must be accompanied by the following items:
Your name, address, telephone number, the serial number, copy of your sales receipt showing the purchase date.

The Model Number is on the box and front of the manual. The Serial Number is on the bottom of the unit. Record the Model and Serial Numbers in the spaces provided below.

Refer to these numbers for warranty service.

Model No.

Serial No.

memo



KD one

4F, KOAMI Bldg., 22, Gukhoe-daero 76-gil, Yeongdeungpo-gu, Seoul,
150-870, Korea/KD One global business Dept.
Website : www.kdone.co.kr